



Laboratory Equipment Manufacturer
www.mrclab.com



INSTRUCTION MANUAL FOR

CL-2006

CHLORINE METER



PLEASE READ THIS MANUAL CAREFULLY BEFORE OPERATION

3, Hagavish st. Israel 58817 Tel: 972 3 5595252, Fax: 972 3 5594529 mrc@mrclab.com

MRC.VER.02-11.10

TABLE OF CONTENTS

1. FEATURES.....	1
2. SPECIFICATIONS.....	2
3. FRONT PANEL DESCRIPTION.....	4
3-1 Cover of Testing bottle.....	4
3-2 Container of Testing bottle.....	4
3-3 Display.....	4
3-4 Hold Button (Esc Button).....	4
3-5 TEST/CAL Button.....	4
3-6 Power Button.....	4
3-7 ZERO Button.....	4
3-8 REC Button (MAX, MIN Button).....	4
3-9 Battery Compartment/Cover.....	4
3-10 1.0 ppm Free Chlorine standard solution.....	4
3-11 1.0 ppm Total Chlorine standard solution.....	4
3-12 Zero Chlorine standard solution.....	4
3-13 Empty testing bottle 1.....	4
3-14 Empty testing bottle 2.....	4
3-15 Clean Cloth.....	4
3-16 Free Chlorine DPD powder (10 PCs).....	4
3-17 Total Chlorine DPD powder (10 PCs).....	4
4. MEASURING PROCEDURE.....	5
4-1 Measurement Consideration.....	5
4-2 Measurement.....	6
4-3 Free/Total Chlorine mode selection.....	8
4-4 Data Hold.....	9
4-5 Data Record (Max., Min. reading).....	9
5. CALIBRATION PROCEDURE.....	10
6. BATTERY REPLACEMENT.....	14

1. FEATURES

- * The meter measures the Free and Total chlorine (CL) in the 0.00 to 3.50 ppm (mg/L).
- * The measuring method is an adaptation of the USEPA Method 330.5 for waste water and Standard Method 4500-Cl G for drinking water.
- * The advanced optical system based on a special narrow band LED lamp that allows most accurate and repeatable reading.
- * Friendly and powerful calibration function are able to validate good performance of your meter at any time.
- * 1.00 ppm Free standard solution and 1.00 ppm Total standard solution are includes as the standard accessories.
- * The unique optics structure, enables the instrument to read with high resolution : 0.01 ppm (mg/L).
- * Splash waterproof on the front panel.
- * Jumbo LCD, easy readout.
- * Microprocessor circuit assures maximum possible accuracy, provides special functions and features.
- * Battery operated for field and on-site testing convenience.
- * Data hold function for freezing the desired value on display.
- * Records Maximum and Minimum reading with Recall.
- * Heavy duty & compact housing with hard carrying case, designed for easy carry out & operation.
- * Auto shut off is available to save battery life.
- * Application : Test swimming pool, municipal water, food and beverage water, or other aqueous solution where fluid clarity is important.

2. SPECIFICATIONS

Circuit	Custom one-chip of microprocessor LSI circuit.
Display	LCD size : 41 mm x 34 mm
Range	Free chlorine (CL) : 0.00 to 3.50 ppm (mg/L). Total chlorine (CL) : 0.00 to 3.50 ppm (mg/L).
Resolution	0.01 ppm (mg/L).
Accuracy	± 0.02 ppm (mg/L). <i>@ 1.00 ppm (mg/L)</i>
Light source	LED, 525 nm.
Light detector	Photo diode
Method	The measuring method is an adaptation of the USEPA Method 330.5 and Standard Method 4500-Cl G. <i>* The reaction between free (total) chlorine and the DPD reagent cause a pink tint in the sample.</i>
Response time	Less than 10 seconds.
Sample volume	10 mL.
Data Hold	Freeze the display reading.
Memory Recall	Maximum & Minimum value.
Display Sampling Time	Approx. 1 second.
Power off	Auto shut off saves battery life or manual off by push button.
Calibration points	Zero chlorine. 1.00 ppm (Free chlorine). 1.00 ppm (Total chlorine).

Operating Temperature	0 to 50 °C .	
Operating Humidity	Less than 85% R.H.	
Power Supply	DC 1.5 V battery (UM4, AAA) x 6 PCs, or equivalent.	
Power Current	Stand by	Approx. DC 4 mA.
	Testing	Approx. DC 12 mA.
Weight	320 g/0.70 LB. @ Battery is included.	
Dimension	155 x 76 x 62 mm (6.1 x 3.0 x 2.4 inch)	
Accessories Included	<ul style="list-style-type: none"> * Instruction manual..... 1 PC * 1.0 ppm Free Chlorine standard solution, CF-01..... 1 PC * 1.0 ppm Total Chlorine standard solution, CT-01..... 1 PC * Zero Chlorine standard solution, CL-01 1 PC * Empty testing bottle..... 2 PCs * Clean cloth..... 1 PC * Free Chlorine DPD powder..... 10 PCs * Total Chlorine DPD powder..... 10 PCs 	
Optional Accessories	<ul style="list-style-type: none"> * Free Chlorine DPD powder (10 PCs), Model : CFP-10 * Total Chlorine DPD powder (10 PCs), Model : CTP-10 * Empty testing bottle, Model : 0601 * 1.0 ppm Free Chlorine standard solution, Model : CF-01 * 1/0 ppm Total Chlorine standard solution, Model : CT-01 * Zero Chlorine standard solution, Model : CL-01 	

3. FRONT PANEL DESCRIPTION

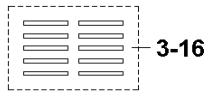
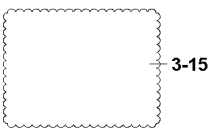
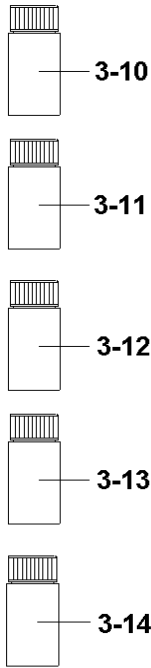
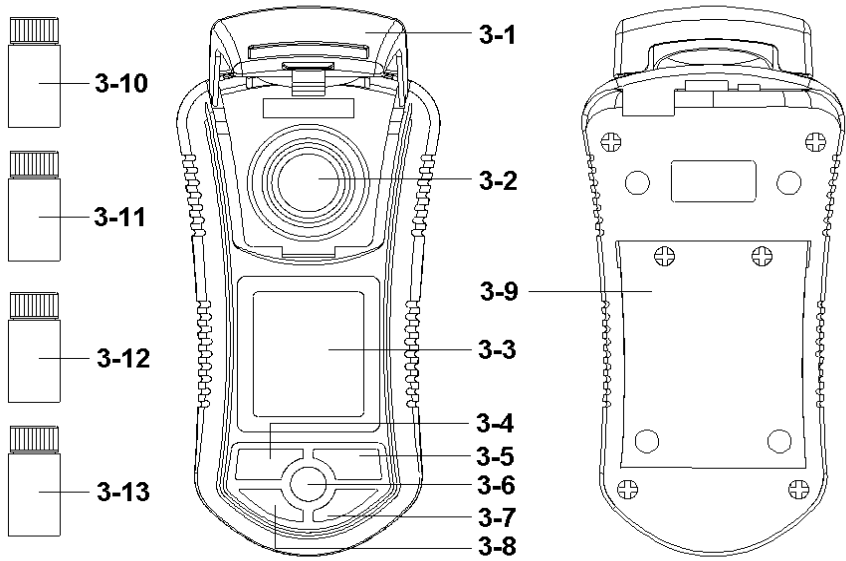

- 3-1 Cover of Testing bottle
- 3-2 Container of Testing bottle
- 3-3 Display
- 3-4 Hold Button (Esc Button)
- 3-5 TEST/CAL Button
- 3-6 Power Button
- 3-7 ZERO Button
- 3-8 REC Button (MAX, MIN Button)
- 3-9 Battery Compartment/Cover
- 3-10 Free Chlorine 1.0 ppm standard solution.
- 3-11 Total Chlorine 1.0 ppm standard solution
- 3-12 Zero Chlorine standard solution
- 3-13 Empty testing bottle 1
- 3-14 Empty testing bottle 2
- 3-15 Clean Cloth
- 3-16 Free Chlorine DPD powder (10 PCs)
- 3-17 Total Chlorine DPD powder (10 PCs)

4. MEASURING PROCEDURE

4-1 Measurement Consideration

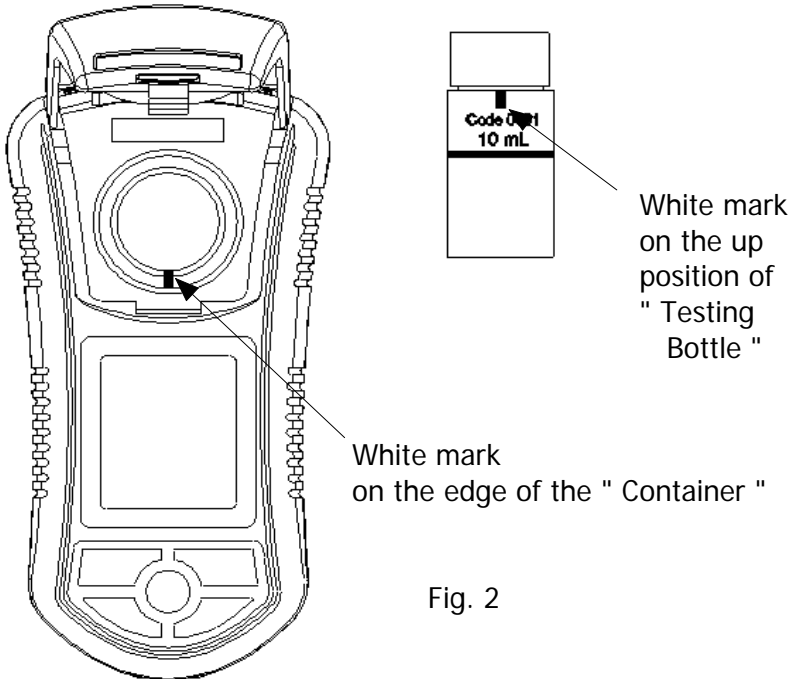

Fig. 2

- 1) There is a " White mark " on the edge of the " Container " (3-2, Fig. 1) and also on the up position of " Testing Bottle " (3-10, 3-11, 3-12 3-13, 3-14 Fig. 1), refer Fig. 2.
- 2) When make the measurement (or calibration), it should keep the " Container white mark " face to face together with the " Testing bottle white mark "



- 3) Insert the " Testing bottle " to the bottom of " Container " (3-2, Fig. 1) completely.
- 4) Before the measurement, it should envelop in the " Cover " (3-1, Fig. 1) completely.

Remark : *Before the measurement, it should keep the outside of Testing Bottle under the dry condition and without existing any dust.*



4-2 Measurement

Before the measurement, should select the measurement model to " Free Chlorine " or " Total Chlorine " first, the setting procedures refer to chapter 4-3, page 8.

ZERO setting for the liquid

- 1) Power ON the meter by pressing the " Power Button " (3-6, Fig. 1) once.
The Display (3-3, Fig. 1) will show the text " Free (TOTAL) " approx. 1 second. then show " CAL 0 ", now the meter for the ZERO setting procedures.
- 2) Fill the measurement liquid into the " Testing bottle " (3-11, 3-12, Fig. 1) .

Attention :

It should fill the measurement liquid capacity until its level up to the " level marker " of the " Testing bottle "

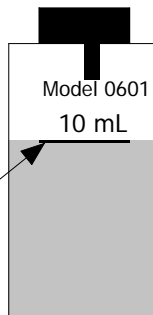

Fig. 3

- 3) Insert the " Testing bottle " to the bottom of " Container " (3-2, Fig. 1) completely.
Before the measurement, it should envelop in the " Cover " (3-1, Fig. 1) completely.
- 4) Press " Zero Button " (3-7, Fig. 1) once, the display will show the text " tEST " (TEST)" with flashing, then show " 0.00 ".

Liquid with the DPD powder

- 5) Take away the " Testing bottle " with the measurement liquid away from " Container " (3-2, Fig. 1).

Fill the DPD powder into the " Testing bottle " with the measurement liquid. It should shake the at least 10 seconds to keep the solution under the uniform condition.

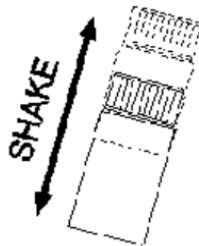

Remark :

- * *For the Free Chlorine measurement, it should use the " Free Chlorine DPD powder ".*
- * *For the Total Chlorine measurement, it should use the " Total Chlorine DPD powder ".*

- 6) **Wait one minute approximately,**
then insert the " Testing bottle " to the bottom of
" Container " (3-2, Fig. 1) completely.
Before the measurement, it should envelop in the
" Cover " (3-1, Fig. 1) completely.
- 7) Press " Test Button " (3-5, Fig. 1) once, the display
will show the text " tEST " (TEST)" with flashing,
wait approx. 10 seconds, the Display will show
the measurement value.



Wash (Reins) the Testing bottle

** After the testing, it should wash (reins)
the Testing Bottle by the Distill Water*

4-3 Free/Total Chlorine mode selection

- 1) **Meter is under the power off conditions.**
Press " Hold Button " (3-4, Fig. 1) " REC Button " (3-8, Fig. 1) at the same time (not release), then
press the " Power Button " (3-6, Fig. 1) will enter the
selection mode to select the function of " Free
Chlorine " or the " Total Chlorine " .
- 2) Press the " TEST Button " (3-5, Fig. 1) to select the
desiring function (Free Chlorine or Total Chlorine),
then " REC Button " to confirm and save the selection
mode into the memory.

Remark :

- * For the swinging pool application, typical to
select the " Free Chlorine " function.*
- * For the industrial water pollution application, typical
to select the " Total Chlorine " function.*

4-4 Data Hold

During the measurement, press the " Hold Button " (3-4, Fig. 1) once will hold the measured value & the LCD will display a " HOLD " symbol.

- * Press the " Hold Button " once again will release the data hold function.

4-5 Data Record (Max., Min. reading)

- * The data record function records the maximum and minimum readings. Press the " REC Button " (3-8, Fig. 1) once to start the Data Record function and there will be a " REC. " symbol on the display.

- * With the " REC. " symbol on the display :

a) Press the " REC Button " (3-8, Fig. 1) once, the " REC. MAX. " symbol along with the maximum value will appear on the display.

b) If intend to delete the maximum value, just press the " Hold Button " (3-4, Fig. 1) once, then the display will show the " REC. " symbol only & execute the memory function continuously.

Press the " REC Button " (3-8, Fig. 1) again, the " REC. MIN. " symbol along with the minimum value will appear on the display.

If intend to delete the minimum value, just press the " Hold Button " (3-4, Fig. 1) once, then the display will show the " REC. " symbol only & execute the memory function continuously.

5. CALIBRATION PROCEDURE

1) The meter can be calibrated under following calibration points :

Free chlorine

- * **Zero**
- * **1.00 ppm**

or

Total chlorine

- * **Zero**
- * **1.00 ppm**

2) The meter ship along with

- * Zero Chlorine standard solution (CL-01) X 1 PC,
- * 1.0 ppm Free Chlorine standard solution (CF-01) X 1 PC.
- * 1.0 ppm Total Chlorine standard solution (CT-01) X 1 PC.

as the standard accessories.

3) The complete calibration should be executed by following two solution :

- * **Zero Chlorine standard solution**
- * **1.0 ppm standard solution (Free or Total).**

4) **Zero chlorine calibration**

- * Insert the " Zero Chlorine standard solution into the " Container " (3-2 , Fig. 1) and envelope in the " Cover " (3-1 , Fig. 1) completely, other procedures please refer to chapter 4-1, 4-2.
- * Press " CAL Button " (3-5, Fig. 1) continuously until the Display show the text " CAL " then release the button.

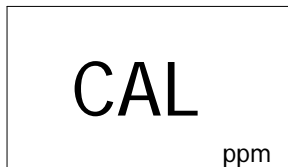

CAL
ppm

- * During the display show text " CAL ", press the " CAL Button " (3-5, Fig. 1), the display will show

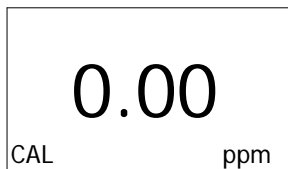

0.00
CAL ppm

Now the meter is ready for the " Zero Chlorine " calibration

- * Press " CAL Button " (3-5, Fig. 1) once, the Display will show following text with flashing (approx. 10 seconds).



Then the Display will show :



Now the meter is finished the " Zero Chlorine " calibration procedures and ready for " 1.00 ppm " calibration procedures.

5) **1.00 ppm calibration**

Refer to page 12, when finish the " Zero Chlorine " calibration procedures and the Display show

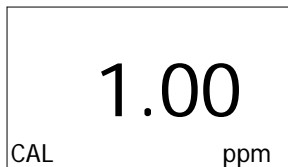

The meter is ready for " 1.0 ppm " calibration.

- * Insert the " 1.0 ppm standard solution into the " Container " (3-2 , Fig. 1) and envelope in the " Cover " (3-1, Fig. 1) completely, other procedures please refer to chapter 4-1, 4-2.

Press " CAL Button " (3-5, Fig. 1) once, the Display will show following text with flashing (approx. 10 seconds).

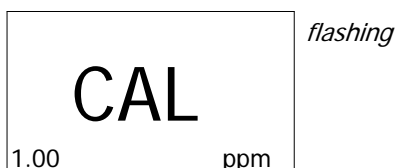

Then the LCD display will return to normal measurement screen, now the meter is finished the calibration procedures (Zero, 1.0 ppm calibration) completely and ready for the measurement.

Remark :

The calibration procedures for the function of " Total chlorine " and the " Free chlorine " are independent.

The complete calibration procedures for the function of " Free chlorine " measurement should be executed by

- * *Zero Chlorine standard solution*
- * *1.0 ppm Free standard solution*

The complete calibration procedures for the function of " Total chlorine " measurement should be executed by

- * Zero Chlorine standard solution
- * 1.0 ppm Total standard solution

6. BATTERY REPLACEMENT

- 1) When the left corner of LCD display show " , it is necessary to replace the battery. However, in-spec. measurement may still be made for several hours after low battery indicator appears before the instrument become inaccurate.
- 2) Loss the " Battery Cover Screws " and slide the " Battery Cover " (3-9, Fig. 1) away from the instrument and remove the battery.
- 3) Replace with DC 1.5 V battery (UM4, AAA, Alkaline/heavy duty) x 6 PCs, and reinstate the cover.
- 4) Make sure the battery cover is secured after changing the battery.